

## SC17 – 17mm Fastflo™ in sand & cement screed with Cliptrack

### Supplied by Nu-Heat

Edge isolation strip

Nu-Heat cliptrack with self-adhesive backing

17mm Fastflo™ tubing

### Supplied by others

Screed

125–250µm polythene protection layer

Insulation

Concrete slab

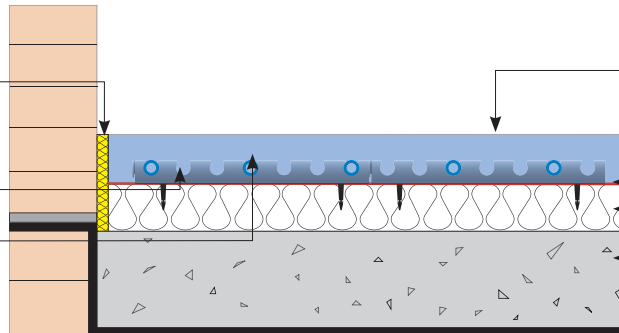

### TECHNICAL INFORMATION

#### Insulation

In ground floors the insulation beneath the screed should meet the requirements of Part L of the Building Regulations.

In upper floors insulation should be a minimum of 30mm rigid insulation board to prevent downward heat transmission. Apart from the edge isolation strip for the perimeter, which is supplied by Nu-Heat, these materials and the polythene protection layer are standard and are most economically sourced from local builders' merchants.

**Note:** The edge isolation strip supplied by Nu-Heat should be fitted around all walls as an expansion medium. This should be the full depth of the floor insulation and screed. On external walls additional insulation material will be required to comply with Building Regulations.

#### Manual handling

Use mechanical lifting aids where appropriate. Use of pipe decoilers is recommended.

#### Tube fixing

Use of a staple gun for securing staples is recommended.

#### Screed

Care should be taken to ensure good contact between the underfloor heating tubes and the screed. It is important that the screed is as dense and consistent as possible to aid heat transfer.

Sand and cement screed should be laid to a minimum depth of 65mm. Areas subject to vehicular traffic or heavy load may require a thicker depth and additional strengthening with mesh. Please consult the screeding company and Nu-Heat.

#### Expansion joints

Expansion joints must be incorporated in areas over 40m<sup>2</sup>, or with length greater than 8m and across doorways and other changes of section. Where tube passes across expansion joints it must be covered with sleeving for at least 200mm either side.

SEQUENCE OF LAYING THE FLOOR

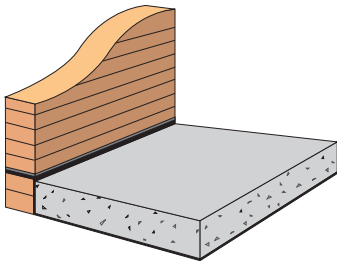

1 Lay the damp-proof membrane (dpm), concrete slab and damp-proof course (dpc) in accordance with current Building Regulations.

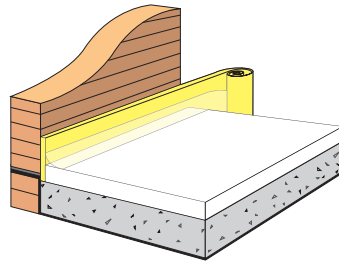

2 Roll out the edge expansion strip around the sides of the room and lay the rigid floor insulation in accordance with current Building Regulations.

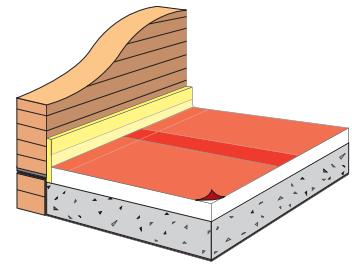

3 Cover with a 125 – 250µm polythene protection layer, overlapping sheets by at least 65mm. This layer is required to protect insulation from the screed.

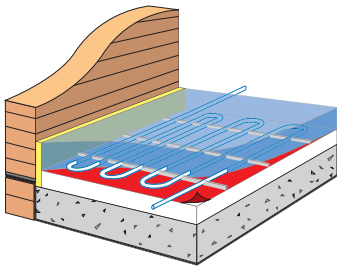

4 Fit the cliptrack and 17mm Fastflo™ tubing as in the instructions on the following page.  
5 Screed the floor whilst the system is under 1 Bar pressure.

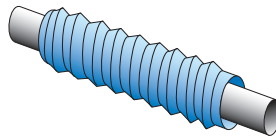

Notes:

On floor areas over 40m<sup>2</sup> a protective sleeve should be used to cover tubing where it crosses expansion joints. Please contact Nu-Heat for supply.

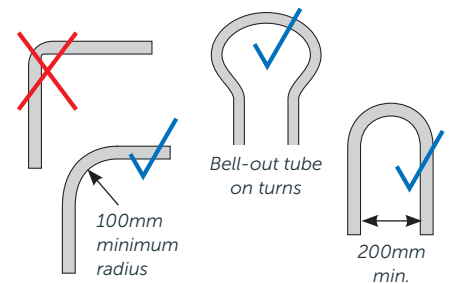

**Never** kink the Fastflo™ tube as this will damage the tube and restrict water flow. It is often easier to bell-out the tube on turns.

## SEQUENCE OF LAYING THE HEATING TUBE IN THE FLOOR

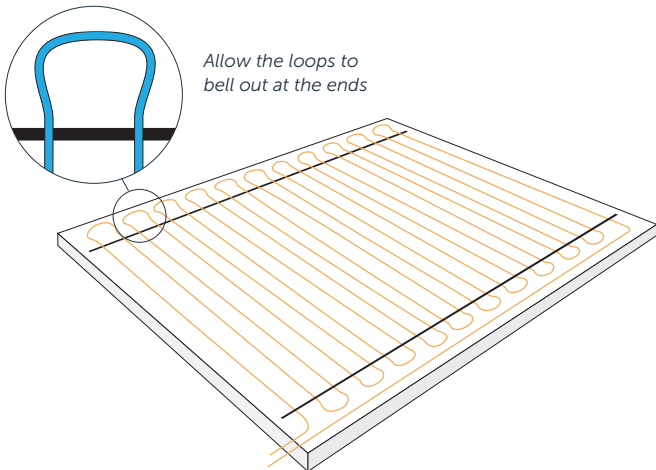
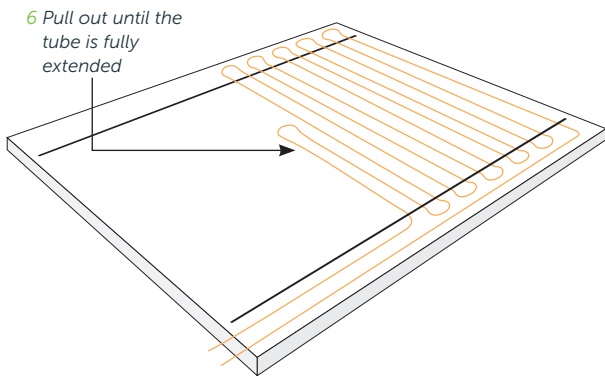
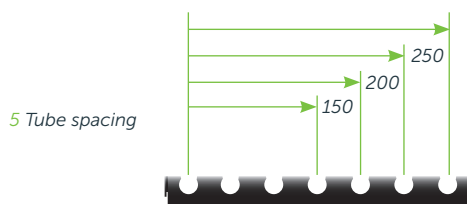
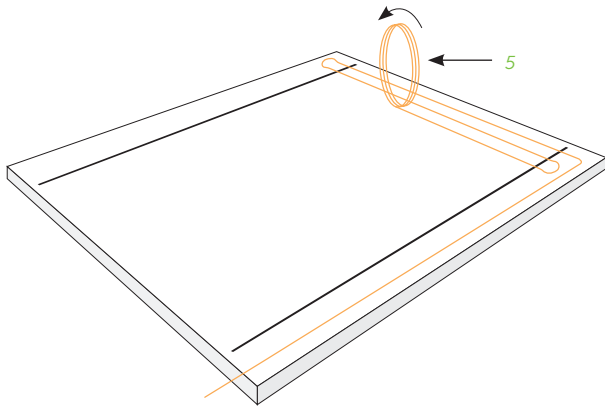

- 1 Fix cliptrack at approximately 0.5m from either end of the room as per CAD drawing and secure with staples.
- 2 Check the pipe cutting plan to ensure the correct coil is utilized to provide the individual cut lengths required for each zone. Each coil is marked every meter with its overall length and remaining coil length.

**Note:** A pipe cutting plan will be provided denoting port allocation against different coil lengths, this will ensure you have enough tube to install the complete system.

All tube coils within a single zone must be no more than 10% different in length.

- 3 Connect one end of the tube to the correct port on the manifold as described in the *Installation Manual*.

**Note:** Label each zone according to the CAD drawing, this ensures the electrician can follow the mechanical installation and not "cross" any zones.

- 4 Start laying the tube from the manifold following the CAD layout.
- 5 On reaching the zone, start unrolling the tube following the CAD layout drawings. Install tubes in pre-installed clip rails, fixing loops and pipe runs with the staples provided. Staples should be installed at one-metre centres for hand-mixed screed.

**Note:** Allow the loops to bell out at the ends if indicated on the CAD drawing; ensure the Fastflo™ pipe is not forced into position resulting in kinking the pipe.

- 6 Carry on installing until either the room is complete or until the room is filled to a position where another coil is required. Return to the manifold position as per drawing detail.
- 7 Now connect cut end to the manifold as in the *Installation Manual*.
- 8 Check next coil length required against the drawings and the pipe splitting schedule, ensuring the correct zones are installed according to the cutting guide and drawings.
- 9 Pressure test in accordance with the *Installation Manual*.